

# UNIVERSAL PLASTIC WRITING TABLET AND ARM

ASSEMBLY INSTRUCTIONS-PLEASE KEEP FOR FUTURE REFERENCE

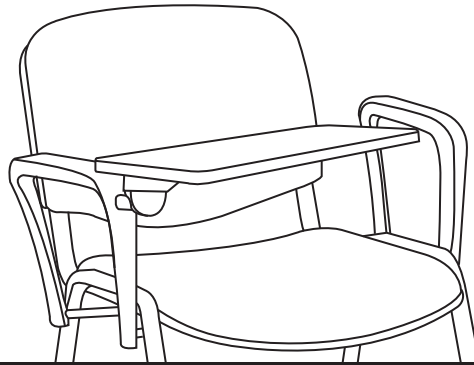

## Important – Please read these instructions fully before starting assembly

- Check you have all the components and tools listed on pages 2 and 3.
- Remove all fittings from the plastic bags and separate them into their groups.
- Keep children and animals away from the work area, small parts could choke if swallowed.

- Make sure you have enough space to layout the parts before starting.
- Do not stand or put weight on the product during assembly, this could cause damage.
- Assemble the item as close to its final position (in the same room) as possible.

- Assemble on a soft level surface to avoid damaging the unit or your floor.
- Parts of the assembly will be easier with 2 people.



- We do not recommend the use of power drill/drivers **for inserting screws**, as this could damage the unit. Only use hand screwdrivers.
- Dispose of all packaging carefully and responsibly.

## Care and maintenance

- Only clean using a damp cloth and mild detergent, do not use bleach or abrasive cleaners.
- From time to time check that there are no loose screws on this unit.
- Do not stand on the chair.
- Do not use this chair as step ladder.
- This product should not be discarded with household waste. Take to your local authority waste disposal centre.

## Handy Hints

- Assemble all parts and bolts loosely during assembly, only once the product is complete should you fully tighten the bolts.
- Regularly check and ensure that all bolts and fittings are tightened properly.

## Components - Parts

Please check you have all the parts listed below

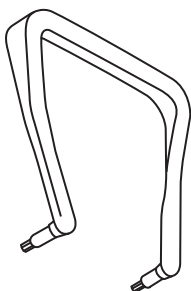

1 Armrest x1

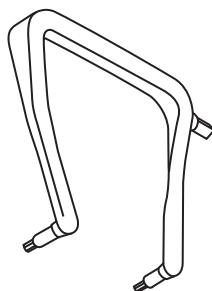

1 Armrest x1

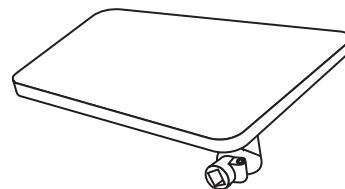

2 Tablet x1

# Components - Fittings

Please check you have all the fittings listed below.

**Note:** The quantities below are the correct amount to complete the assembly.  
In some cases more fittings may be supplied than are required.

**A**

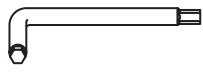

Allen Key (supplied)

## Assembly Instructions

### Step 1

#### Fitting the armrest

Insert the armrest **1** in the seat frame.  
Use an hammer for help you to fit.

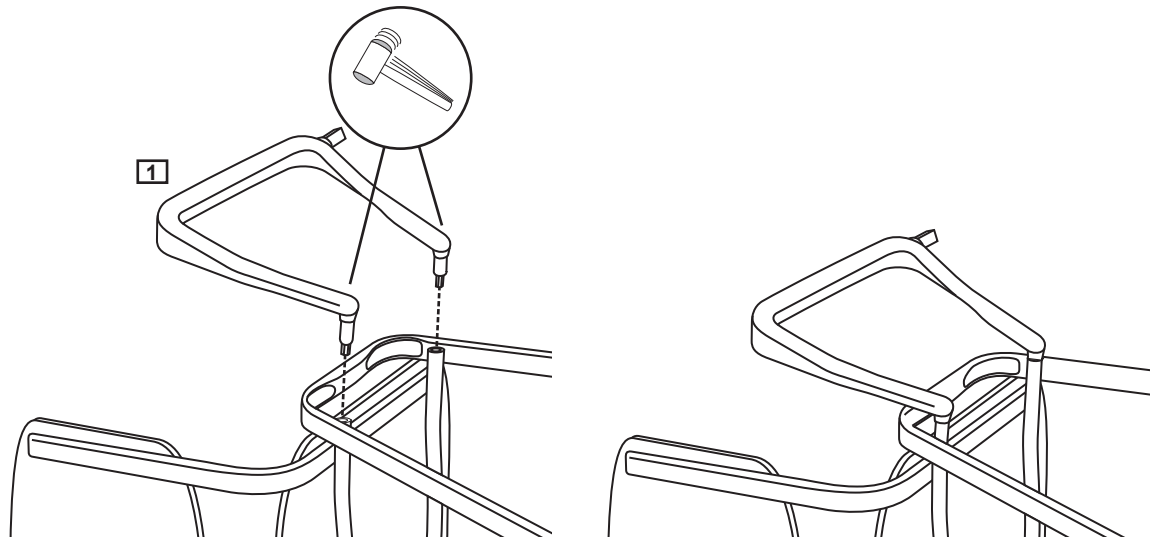

### Step 2

#### Assembly the tablet

Insert the tablet **2** into the armrest **1**.

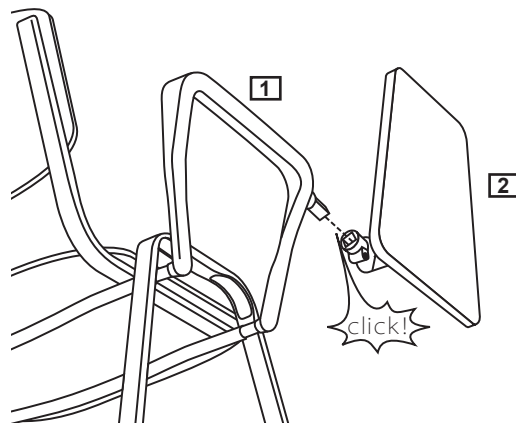

### Step 3

#### Fitting the tablet

Use the allen key **A** to fix the tablet.

