

DENALI MID BACK MESH CHAIR BLACK

ASSEMBLY INSTRUCTIONS-PLEASE KEEP FOR FUTURE REFERENCE



Important-please read these instructions fully before starting assembly

Safety and Care Advice

Important – Please read these instructions fully before starting assembly

- Check you have all the components and tools listed on pages 2 and 3.
- Remove all fittings from the plastic bags and separate them into their groups.
- Keep children and animals away from the work area, small parts could choke if swallowed.
- Make sure you have enough space to layout the parts before starting.

- Do not stand or put weight on the product during assembly, this could cause damage.
- Assemble the item as close to its final position (in the same room) as possible.
- Assemble on a soft level surface to avoid damaging the unit or your floor.
- Parts of the assembly will be easier with 2 people.



- We do not recommend the use of power drill/drivers **for inserting screws**, as this could damage the unit. Only use hand screwdrivers.
- Dispose of all packaging carefully and responsibly.

Care and maintenance

- Only clean using a damp cloth and mild detergent, do not use bleach or abrasive cleaners.
- From time to time check that there are no loose screws on this unit.

- Do not stand on the chair.
- Do not use this chair as step ladder.
- This product should not be discarded with household

waste. Take to your local authority waste disposal centre.

Handy Hints

- Assemble all parts and bolts loosely during assembly, only once the product is complete should you fully tighten the bolts.
- Regularly check and ensure that all bolts and fittings are tightened properly.

Components - Parts

Please check you have all the parts listed below

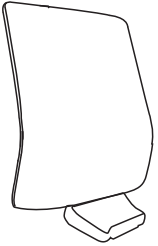

1 Backrest x1

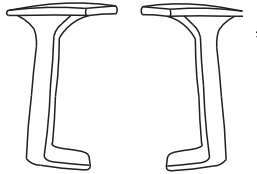

2 Left armrest x1 & Right armrest x 1

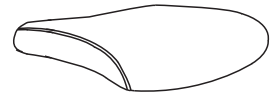

3 Seat x 1

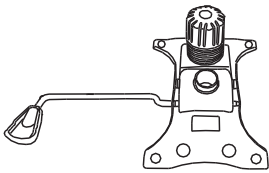

4 Seat plate x 1

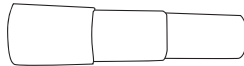

5 Gas lift cover x 1



6 Gas lift x 1

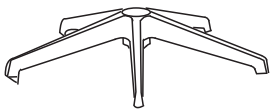

7 Base x 1







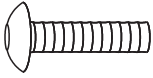

8 Castors x 5

Components - Fittings

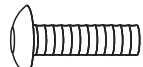
Please check you have all the fittings listed below.

Note: The quantities below are the correct amount to complete the assembly.
In some cases more fittings may be supplied than are required.

A  30mm Bolts x 6	B  20mm Bolts x 4	C  35 mm Bolts x 4
D  Washer x 14	E  Spring washer x 14	F  M5 Allen key (supplied)

Assembly Instructions

Step 1

Fitting the base

a: Push all the five castors **(8)** into the underside of the base **(7)**.

Insert the gas lift **(6)** into the base **(7)**. Put the gaslift cover **(5)** onto the gaslift **(6)**.

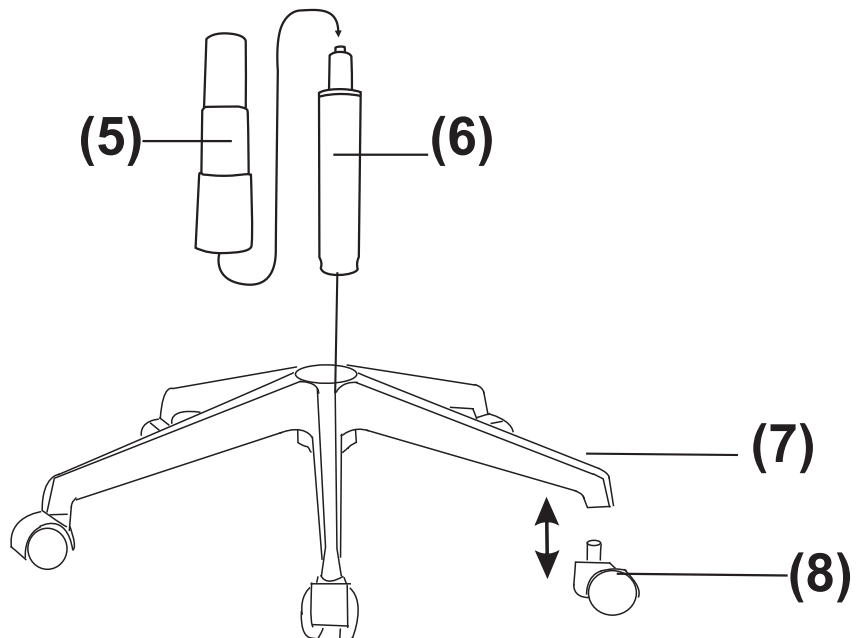

Step 2

Fitting the Armrests

Use bolts **(A)** and washer **(D)** and spring washer **(E)** to fix the armrests **(2)** and seat **(3)**.

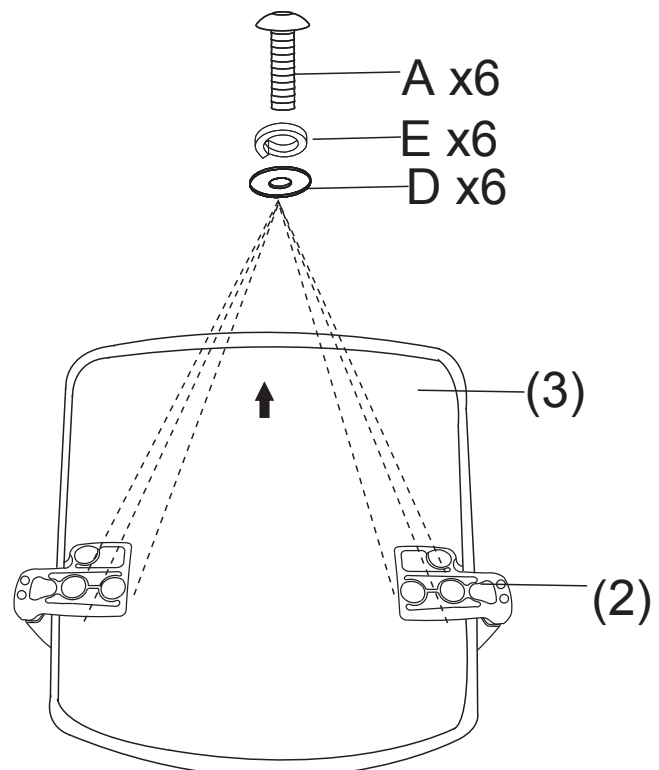

Assembly Instructions

Step 3

Fitting the Seat Cushion

Use bolts **B** and washer **D** and spring washer **E** to fix the seat plate **4** onto the seat **3**. Ensure the plate **4** is fitted to the seat with correct orientation.

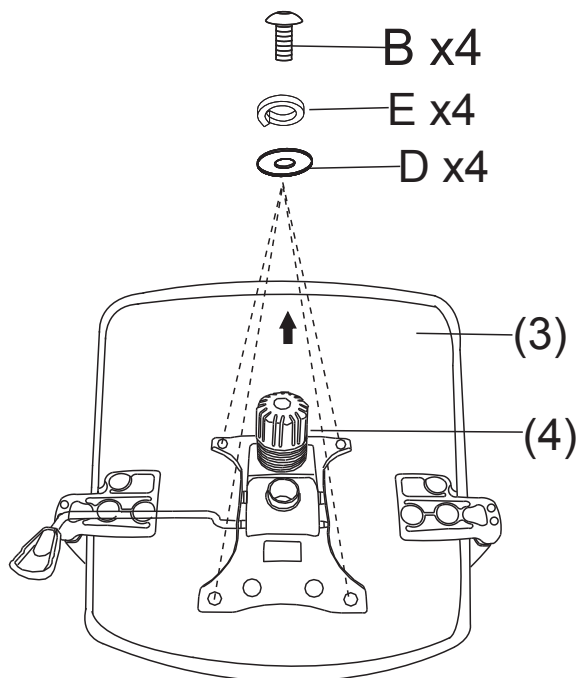

Step 4

Fitting the Backrest

Use bolts **C** and washer **D** and spring washer **E** to fix the backrest **1** onto the seat **3**.

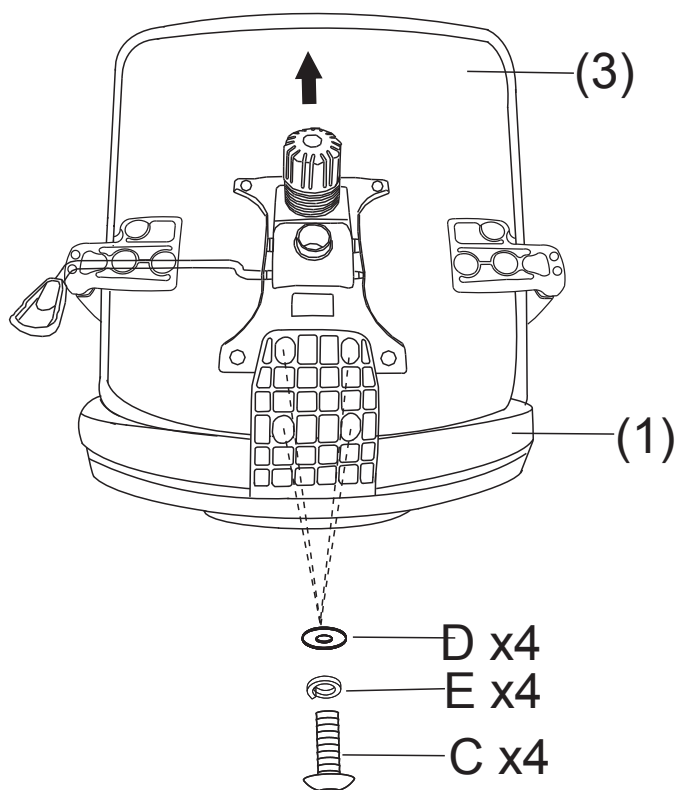

Assembly Instructions

Step 5

Carefully locate the seat **3** onto the base unit.

